



MODEL 2114-OWS OIL / WATER LEVEL TRANSMITTER

User Manual

Technical Support
Continental North America Toll Free 1-(800) 387-9487
Ph: +1 (905) 829-2418 Fx: +1 (905) 829-4701

A Product of Arjay Engineering Ltd.
Oakville, Ontario, Canada

INTERNET www.arjayeng.com

Oil/Water Separator Level Monitor



Continuous interface monitoring of static level oil/water separators for oil level indication, control and alarm

Over 30 years of Arjay's field proven HF capacitance technology has been applied to the 2114-OWS oil/water separator monitors. The sensing probe continuously monitors for oil to control pumps, operate valves, or activate alarms.

- capacitance technology does not foul or require cleaning
- no moving parts
- remote alarm unit mounts safely away from pipe

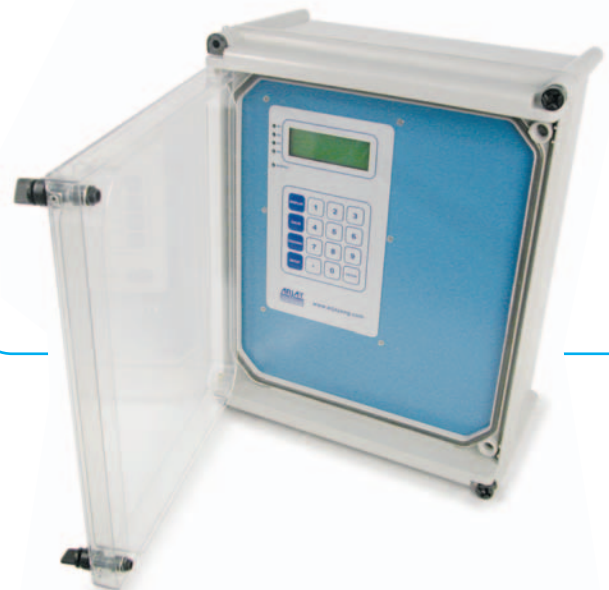

2114-OWS

The 2114-OWS sensing probe monitors the capacitance field between the probe and its concentric shield. As the volume of separated oil increases in the separator, the probe capacitance changes. This proportional change is used to indicate the separated oil level and provide relay control.

■ Features and Benefits

- no moving parts
- remote electronics via standard twisted pair
- one controller can monitor up to two probe inputs
- available with Intrinsic Safety Barrier for Hazardous Locations
- high corrosion resistant Teflon and stainless steel wetted parts
- capacitance technology responds to all oil types
- HF capacitance technology does not require routine cleaning
- easy calibration and control set-up

■ Technical Specifications - Control Unit

Operating Temperature	-20°C to 60°C
Power Input	24 vdc or 110 vac or 220 vac
Analog Output	4-20 mA proportional to oil level
Interface	RS-485 Modbus available
Display	backlit display of oil level
Alarm Relays	4 x 10 amp, SPDT, dry
Standards	UL, CSA, CE
Enclosure	Type 4X

■ Technical Specifications - Probe

Operating Temperature	0°C to 50°C
Approval	CSA Class 1, Zone 2, Div 2, Groups A,B,C,D (also available with an Intrinsic Barrier option)



All calibration, control relays and power wiring is available at the main control unit. This can be safely mounted up to 1 km away from the separator.

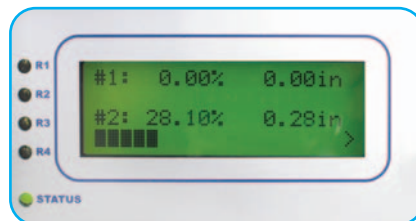

The four line backlit display provides menu driven set-up functions and a display of up to two probe inputs



The unique PMC circuit design, exclusive to Arjay, immediately converts the sensor signal to a frequency pulse for furtherance to the controller.



Arjay Engineering Ltd.
2851 Brighton Road
Oakville, Ontario
Canada L6H 6C9

tel
fax
N. America
email
web

++1 905-829-2418
++1 905-829-4701
1-800-387-9487
arjay@arjayeng.com
www.arjayeng.com



<u>MODEL</u> 2114OWS	<u>DOCUMENT TYPE</u> USER MANUAL	<u>DOCUMENT FILE NAME</u> 2114owsum43.doc	<u>REV.</u> 4.3
<u>CREATE DATE</u> January 17, 2006 10:11 AM	<u>REV. DATE</u> Feb.21/01	<u>PRINT DATE</u> March 6, 2006 10:10 AM	

TABLE OF CONTENTS

1.0	INSTRUMENT OVERVIEW.....	3
1.1	FEATURES	3
1.2	DESCRIPTION	3
2.0	INSTALLATION	5
2.1	PROBES.....	5
2.2	PROBE INSTALLATION	5
2.4	ELECTRICAL INSTALLATION.....	9
3.0	STARTUP AND CALIBRATION	10
3.1	NOTES ON VALUE ENTRY	10
3.2	POWERUP DISPLAY	11
3.3	MINIMUM SETUP	11
3.3.1	XMTR VALUES.....	11
3.3.2	DATA FILTER (SMOOTHING)	11
3.3.3	ENGINEERING UNITS.....	12
3.3.4	TAG NUMBER.....	12
3.3.5	mA SETTINGS.....	12
3.3.6	RELAY SETTINGS	13
3.3.7	CALIBRATION.....	15
3.3.7.1	CHECK OIL SENSITIVITY (SLOPE) SETTING	15
3.3.7.2	QUICK CAL (ONE POINT)	15
3.3.7.3	ACTIVE PROBE LENGTH.....	16
3.3.8	ENABLE ALARM RELAY CONTROL.....	16
4.0	OPERATION	17
4.1	DISPLAY MENU [DISP]	18
4.2	CALIBRATION [CALIB]	18
4.3	CONTROL MENU [CONT]	18
4.3.1	mA SETTINGS.....	18
4.3.2	RELAY SETTINGS	18
4.3.3	RELAY SETTINGS SELECTION.....	19
4.3.4	RELAY SETTINGS EXAMPLE	20
4.4	SETUP [SETUP].....	20
4.4.1	PMC 2000 (Manual) [SETUP \ 1 \ 2].....	20
4.4.2	DIAGNOSTICS [SETUP \ 2].....	21
4.4.3	SETTINGS MENU [SETUP \ 3]	21
5.0	TROUBLESHOOTING	23
6.0	CONTROLLER SETTINGS SHEET	25

MODEL 2114OWS	DOCUMENT TYPE USER MANUAL	DOCUMENT FILE NAME 2114owsum43.doc	REV. 4.3
CREATE DATE January 17, 2006 10:11 AM	REV. DATE Feb.21/01	PRINT DATE March 6, 2006 10:10 AM	

1.0 INSTRUMENT OVERVIEW

1.1 FEATURES

- Display of oil level in Oil/Water Separators
- Galvanically isolated probe inputs
- 1 Point automatic calibration for oil on water
- RF Technology
- Arjay pulse card system for simple, safe, remote control, calibration and maintenance
- 1 timed (user set) relay (SPDT 10A contacts) to activate an oil removal pump
- 2 general purpose alarm relays for oil level alarms (SPDT 10A contacts)
- 1 relay (SPDT 10A contacts) to indicate instrument error for remote status
- Isolated mA output per probe Independently selectable as Direct / Inverse & 4-20 / 0-20mA output with offset capability
- RS-485 Network / Modbus protocol
- No moving parts
- For use with any Arjay Capacitance probe

1.2 DESCRIPTION

The unit senses level using a RF capacitance measurement technique for very high resolution measurements. The Oil Level in the Oil/Water Separator is measured by the 2114OWS by measuring the capacitance of a concentrically shielded Arjay Capacitance Probe. As oil displaces the water in the vessel, the measured capacitance of the level probe decreases linearly and can be used to display %oil level and to provide signals and controls.

Probe inputs and mA outputs are all galvanically isolated to minimize electrical interference.

The Arjay Level-Ease 2000 Series system uses RF (radio Frequency) methodology to measure the vessel capacitance. This technique minimizes the effects of other electrical properties of the probe, vessel, and vessel contents and focuses only on the vessel capacitance. The controller may be located up to one km away from an Arjay probe via inexpensive 2 wire shielded cable.

A 20 character by 4 line LCD and 16 key membrane keypad offer detailed data displays plus ease of calibration and setup. Level is displayed in percentage fill and in user selectable engineering units. In addition a bar graph gives a quick indication of level.

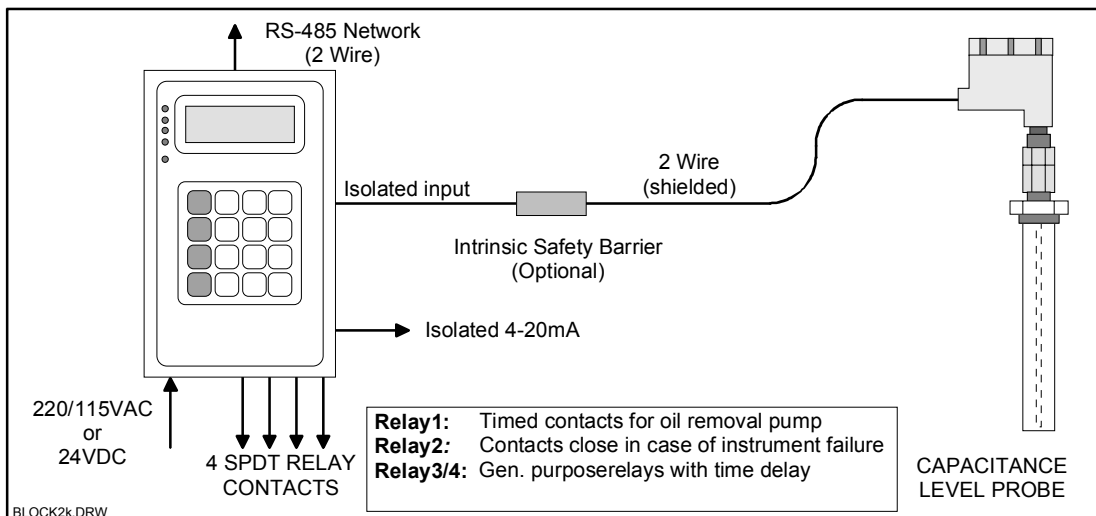

Figure 1.0

HARDWARE REV. 3.0	SOFTWARE REV. 2040_12 and higher	Page 3 of 26
-----------------------------	--	--------------

<u>MODEL</u> 2114OWS	<u>DOCUMENT TYPE</u> USER MANUAL	<u>DOCUMENT FILE NAME</u> 2114owsum43.doc	<u>REV.</u> 4.3
<u>CREATE DATE</u> January 17, 2006 10:11 AM	<u>REV. DATE</u> Feb.21/01	<u>PRINT DATE</u> March 6, 2006 10:10 AM	

OPERATION

The Oil Level in the Oil/Water Separator is measured by measuring the capacitance of a concentrically shielded Arjay Capacitance Probe. As oil displaces the water in the vessel, the measured capacitance of the level probe decreases linearly and can be used to display oil level and to provide signals and controls.

USER INTERFACE

Display	4 line X 20 Character LCD with optional backlight + bar graph.
Keypad	4x4 Membrane type matrix.
Network	RS-485 / Modbus protocol

PERFORMANCE

Range	0-20 feet.
Resolution	0.1 inches of oil.
Accuracy	±0.2% of Full Scale

INPUTS

2 wire plus shield connection to an Arjay PMC-2000 module located in any Arjay Capacitance probe head.

OUTPUTS / RELAYS

mA output	0.05% resolution, sourced into 900 Ohms maximum load.
Relay specs.	4 SPDT 10A/120VAC contacts:
Relay 1:	Selectable alarm point to turn on oil removal pump for an adjustable period of time (2 - 600 seconds).
Relay 2:	Energized in case of instrument failure: Normally de-energized.
Relays 3&4:	Alarm point set over full scale oil range. Programmable time delay: 0 - 99 seconds. Hi Fail-safe selectable.

POWER

115VAC @ 10VA or 220VAC or 24VDC @ 0.4A max. (specify at time of order)

MECHANICAL SPECIFICATIONS

Enclosure	sub plate mount, (optional wall Mount Type Nema 4X enclosure).
Dimensions	5.3" x 8.5" x 2.5" (Wall Mount Nema 4X: 14" x 12" x 7").
Weight	2.2 kg (5lb) max. (Wall Mount Nema 4X: 6kg (13lbs)).

ENVIRONMENTAL SPECIFICATIONS

Operating Temp.	-20 to 60 Deg. C for Controller only. Probe Head:-40 to 80 Deg. C
Relative Humidity	90% max. with no condensation.

<u>HARDWARE REV.</u> 3.0	<u>SOFTWARE REV.</u> 2040_12 and higher	Page 4 of 26
-----------------------------	--	--------------

<u>MODEL</u> 2114OWS	<u>DOCUMENT TYPE</u> USER MANUAL	<u>DOCUMENT FILE NAME</u> 2114owsum43.doc	<u>REV.</u> 4.3
<u>CREATE DATE</u> January 17, 2006 10:11 AM	<u>REV. DATE</u> Feb.21/01	<u>PRINT DATE</u> March 6, 2006 10:10 AM	

2.0 INSTALLATION

NOTE: If any damage to the instrument is found, please notify an Arjay Engineering representative as soon as possible prior to installation.

2.1 PROBES

Capacitance probes may be selected from a variety of styles for use with liquids, liquid interfaces, and granular materials. The probe length is customer specified for the height of material desired to be measured. Usually Teflon coated probes are used.

2.2 PROBE INSTALLATION

The standard probe used for Oil Water Separator (OWS) applications comes with a 2 inch NPT concentric shield. Flanges are available as options. The entrance configuration may vary depending on the application requirements.

TO SCREW IN PROBE (THREADED ENTRY) USE WRENCH ON LOWER 2 INCH HEX BUSHING. The probe fittings are compression type with Teflon ferrules assembled by applying torque between the two hex sections. The fittings are sealed at the factory to provide a compression seal capable of withstanding high pressures. Once opened they cannot be reassembled without new ferrules.

The probe should be mounted vertically and parallel to a reference ground surface which is typically the vertical wall of the tank or a concentric shield around the probe. The following points are important when installing the probe:

- 1- **Reference ground:** For OWS applications, a concentrically shielded probe is required in which case the shield provides its own Ground.
- 2- **The measurement accuracy can be affected by the temperature change of the material in the tank.** The amount of measurement error depends on the material. If the temperature change is excessive, temperature correction may be required. Contact the Arjay representative for more information.

MODEL 2114OWS	DOCUMENT TYPE USER MANUAL	DOCUMENT FILE NAME 2114owsum43.doc	REV. 4.3
CREATE DATE January 17, 2006 10:11 AM	REV. DATE Feb.21/01	PRINT DATE March 6, 2006 10:10 AM	

CONCENTRIC SHIELD ENTRY

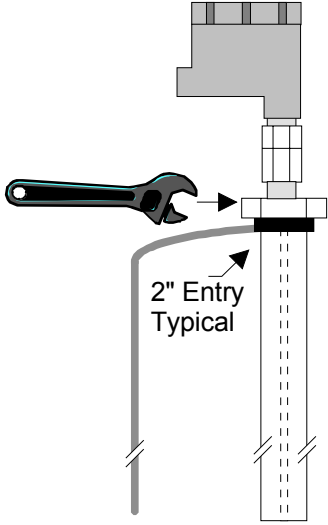

- 1- For threaded and flanged entry types, the probe must be parallel to the tank wall
- 2- For threaded and flanged entry types, measurement sensitivity is increased by reducing the probe to wall distance.
- 3- There should be good electrical conductivity between the tank wall and the transmitter enclosure. (For probes with a concentric shield this is not important).

INSTALL PROBE WITH CARE: IF TEFLON COATING IS DAMAGED, THE PROBE WILL NOT WORK

- 1- Remove probe cover
- 2- If PMC-2000 is not already installed, bolt it into the standoffs in the base of the probe enclosure. The orange connector should face away from the probe.
- 3- Remove the mating connector and wire it as shown. The shield **SHOULD NOT BE CONNECTED**. Plug the connector back.
- 4- **IMPORTANT!** the enclosure **MUST BE EARTH GND**ED. Either via tank if it is connected to earth gnd or via a separate gnd connection to the **GROUND LUG**.

PROBE HEAD TOP VIEW WITH COVER REMOVED

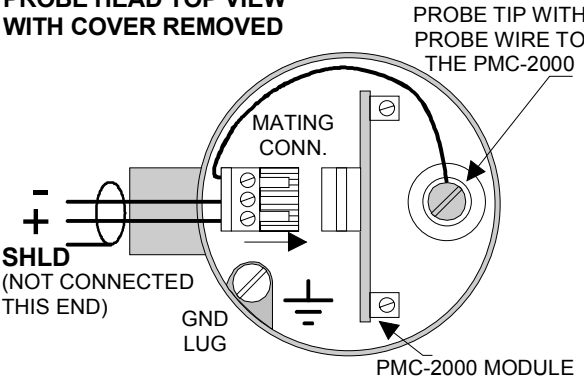

PROBE INSTALLATION

PROBE.DRW

Figure 2.0

MODEL 2114OWS	DOCUMENT TYPE USER MANUAL	DOCUMENT FILE NAME 2114owsum43.doc	REV. 4.3
CREATE DATE January 17, 2006 10:11 AM	REV. DATE Feb.21/01	PRINT DATE March 6, 2006 10:10 AM	

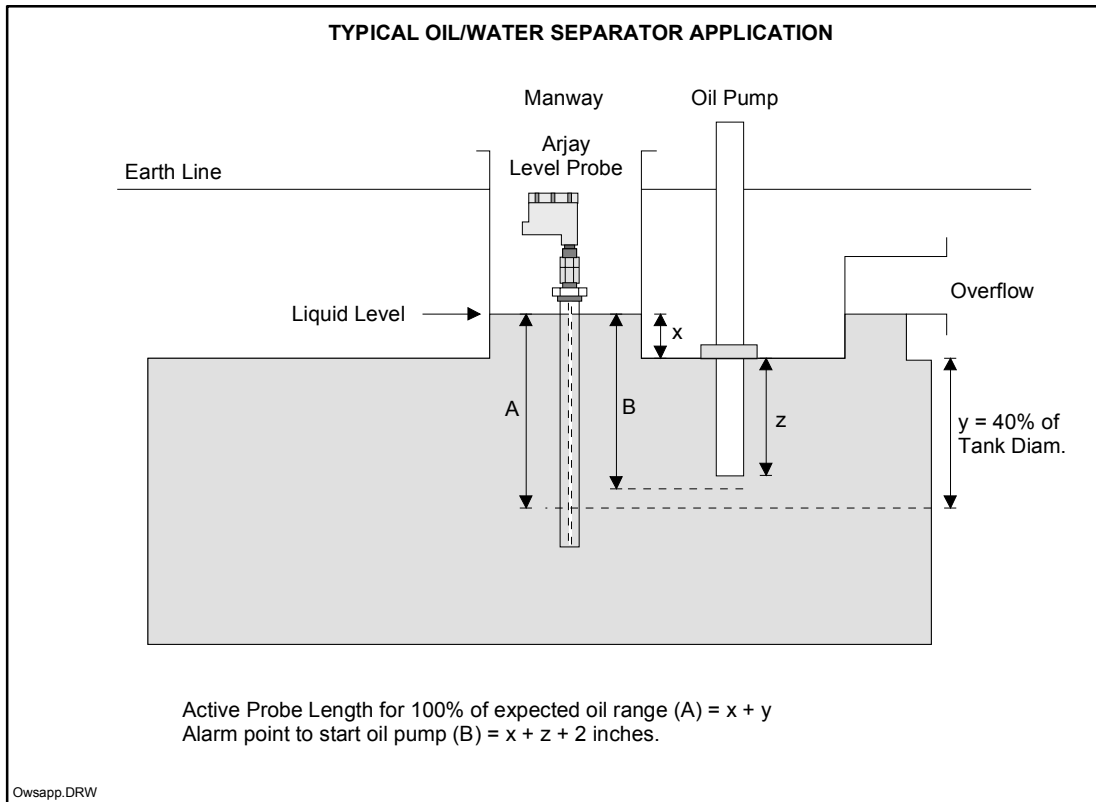

Figure 2.1

Figure 2.1 shows a typical Oil/Water Separator application. The Active Probe Length (A) is the length along the probe corresponding to the maximum anticipated oil level.

It is important that the overall liquid level (oil and water) should be a constant i.e. the only variable is the oil / water interface level and not the total liquid level.

MODEL 2114OWS	DOCUMENT TYPE USER MANUAL	DOCUMENT FILE NAME 2114owsum43.doc	REV. 4.3
CREATE DATE January 17, 2006 10:11 AM	REV. DATE Feb.21/01	PRINT DATE March 6, 2006 10:10 AM	

2.3 MECHANICAL INSTALLATION

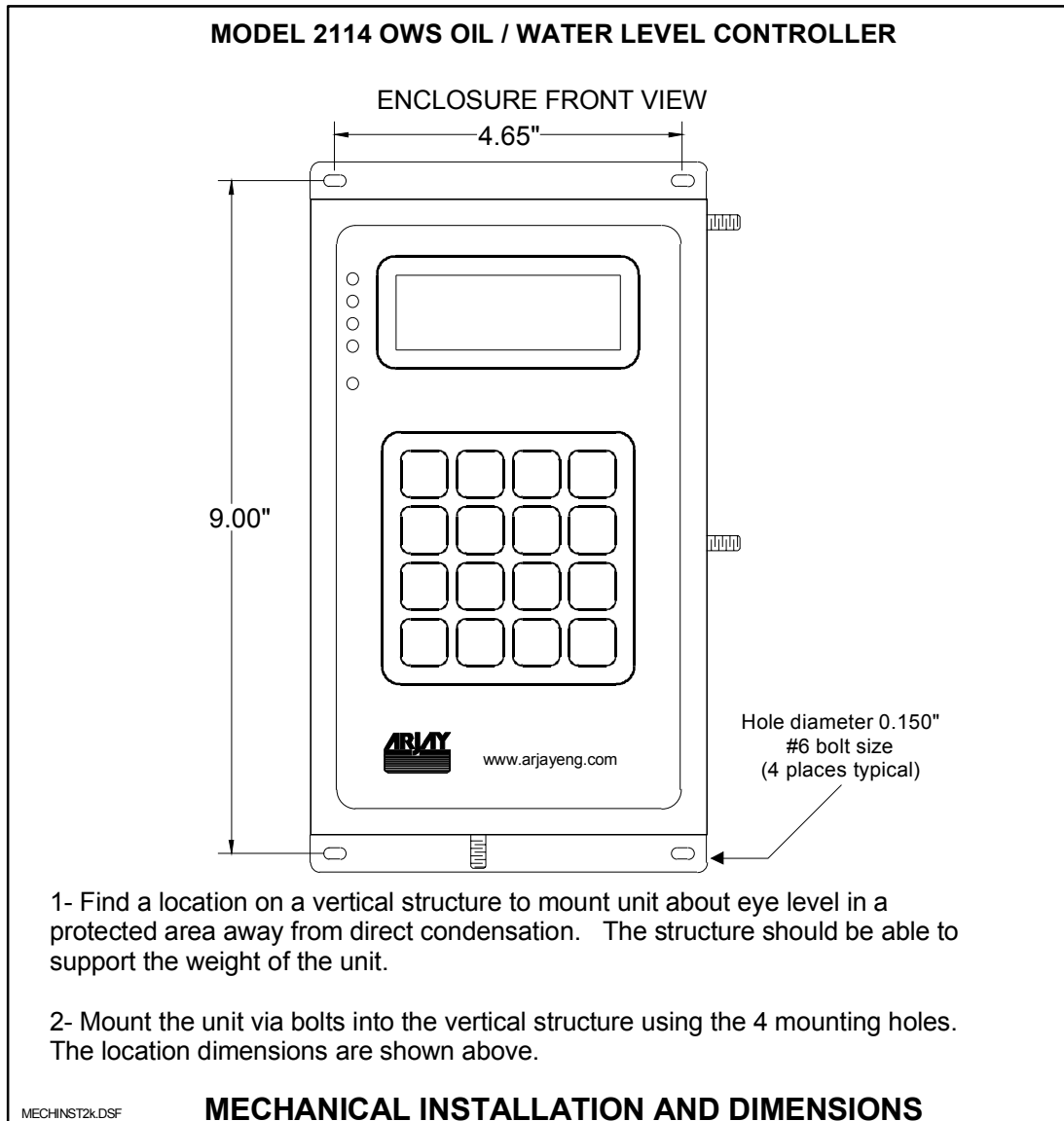

Figure 2.1

MODEL 2114OWS	DOCUMENT TYPE USER MANUAL	DOCUMENT FILE NAME 2114owsum43.doc	REV. 4.3
CREATE DATE January 17, 2006 10:11 AM	REV. DATE Feb.21/01	PRINT DATE March 6, 2006 10:10 AM	

2.4 ELECTRICAL INSTALLATION

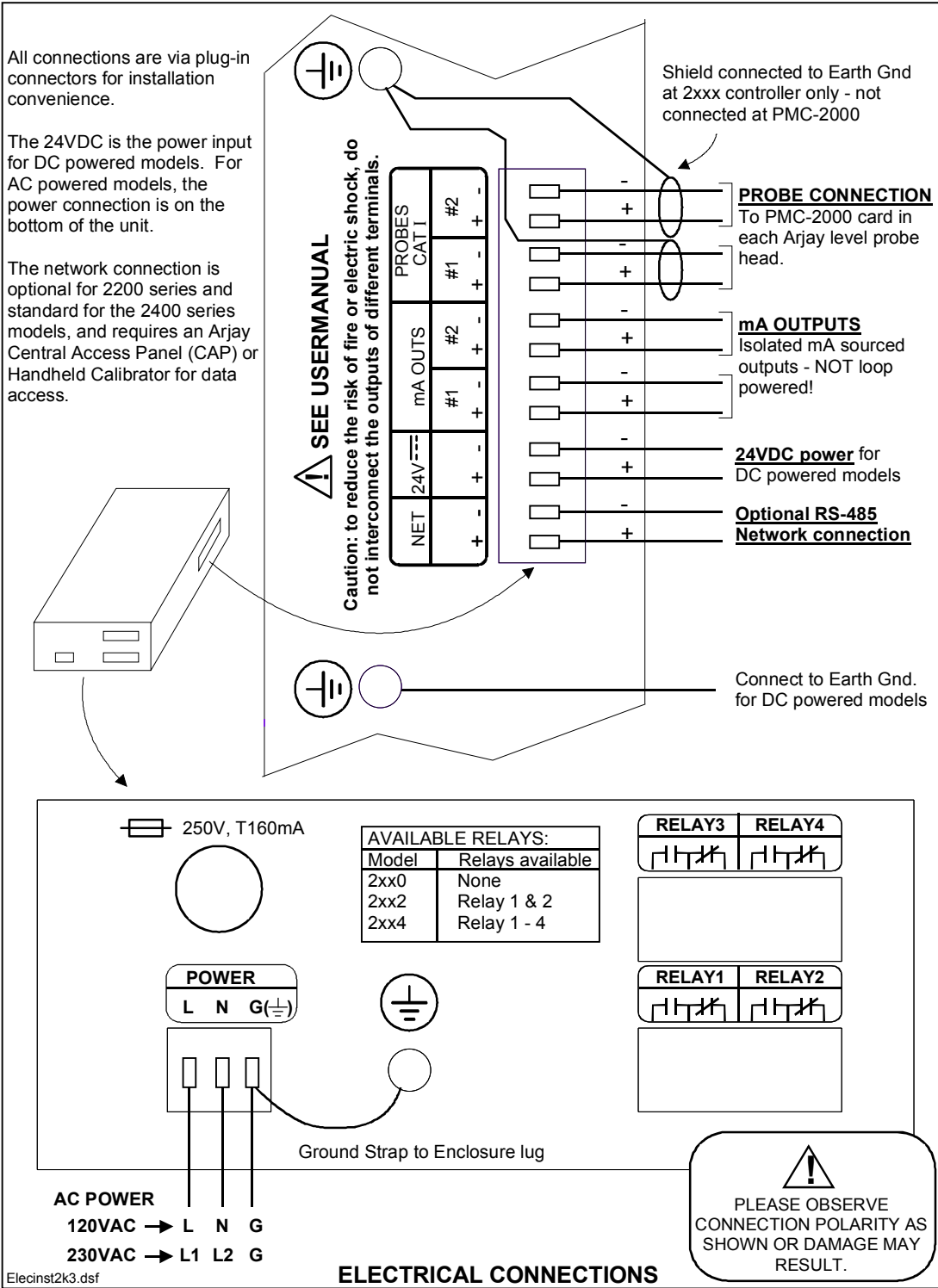

Figure 2.2

HARDWARE REV. 3.0	SOFTWARE REV. 2040_12 and higher	Page 9 of 26
-----------------------------	--	--------------

MODEL 2114OWS	DOCUMENT TYPE USER MANUAL	DOCUMENT FILE NAME 2114owsum43.doc	REV. 4.3
CREATE DATE January 17, 2006 10:11 AM	REV. DATE Feb.21/01	PRINT DATE March 6, 2006 10:10 AM	

3.0 STARTUP AND CALIBRATION

This section is provided for minimum setup. For a more detailed description of features please refer to Section 4.0.

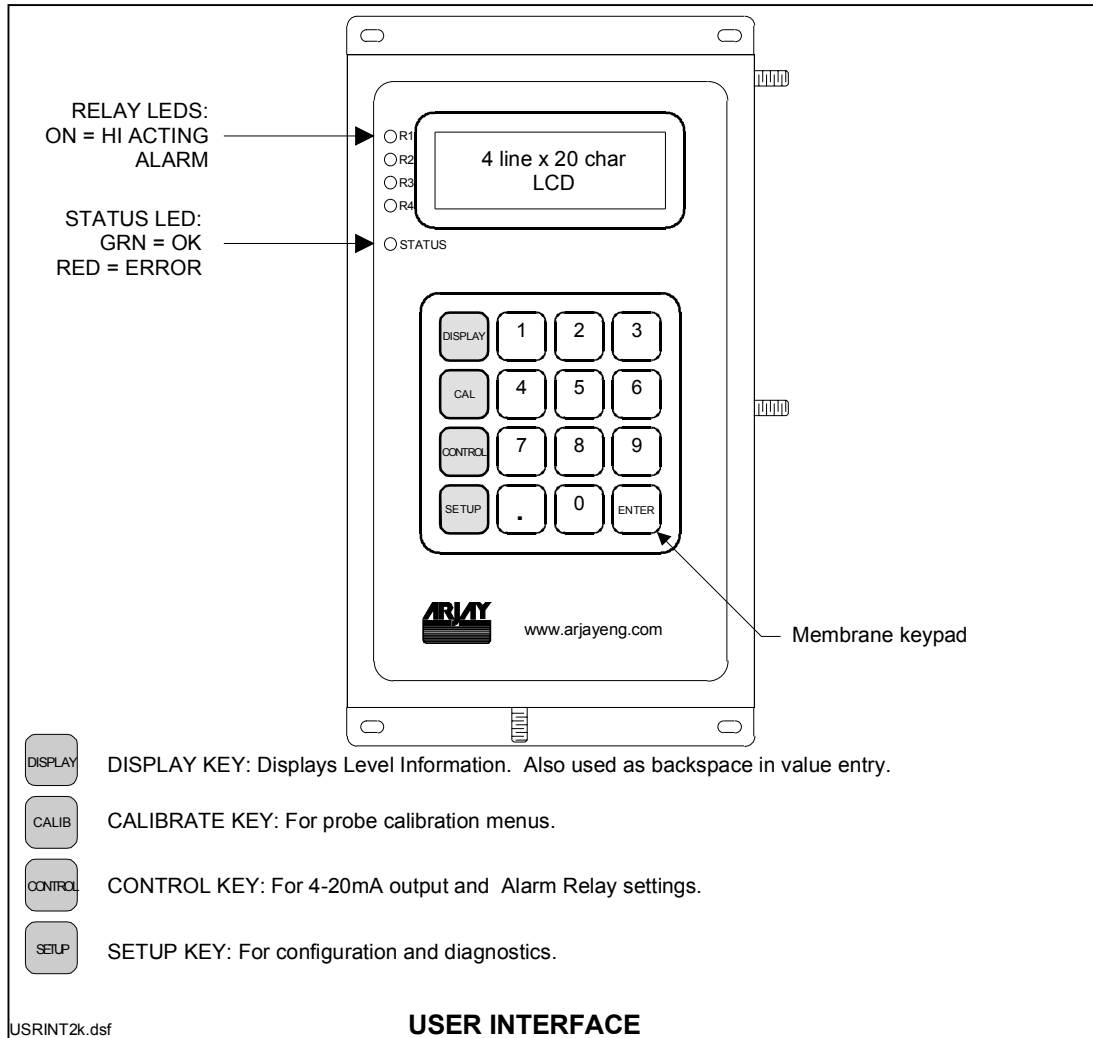

Figure 3.0

3.1 NOTES ON VALUE ENTRY

When entering in numeric values, the cursor can be backspaced to correct mistakes by pressing the DISPLAY key. This is only true if the cursor is not at the beginning of the displayed value, in which case the DISPLAY menu is entered.

Values may be entered with any number of places of decimal.

If the entered value is out of the allowed limits, the system displays the limiting value for 2 seconds. For example if the mA Span value is entered as 5000.0% then **MAX. 100** is displayed for 2 seconds then entry is allowed again. The current value is not changed unless the entered value is within limits.

<u>MODEL</u> 2114OWS	<u>DOCUMENT TYPE</u> USER MANUAL	<u>DOCUMENT FILE NAME</u> 2114owsum43.doc	<u>REV.</u> 4.3
<u>CREATE DATE</u> January 17, 2006 10:11 AM	<u>REV. DATE</u> Feb.21/01	<u>PRINT DATE</u> March 6, 2006 10:10 AM	

During value entry, the capacitance and level are still being constantly updated in the background. Apart from the CALIBRATION menu and the DIAGNOSTICS menu, in all other menus, the Alarm relays and the mA output are also updated.

3.2 POWERUP DISPLAY

After mechanical and electrical installations of the probe(s) and the controller have been successfully completed, power up the unit. The following startup screen will be displayed for about 3 seconds:

Arjay Engineering
Level-Ease 2114OWS
Rev: 3.00 / 2040_12
S/N: 001234

The Rev. line displays the Hardware Revision followed by the Software Revision separated with a “/”. The Serial Number is displayed by itself on the bottom line.

After the startup screen, the LCD should show a screen similar to:

OIL LEVEL
3.28 in
27.33 %
□□□□

NOTE: The shown values are for example only.

The 2nd line shows the oil level in engineering units. One of 8 engineering units may be selected in the configuration menu as described in the next sub-section.

The 3rd line shows the oil level in percent. This value is independent of the engineering units.

The 4th line displays a bargraph of the percent capacity. The resolution is 5%.

The Status Indicator (see figure 3.0) should be green. If this is red then the LCD displays the kind of System Error. See the troubleshooting guide for details.

3.3 MINIMUM SETUP

3.3.1 XMTR VALUES

- Press the SETUP key, then 1 for Xmtr Set, then 2 for Manual. This menu enters the PMC-2000 level transmitter module's calibration parameters. These parameters are printed on a label affixed to the PMC-2000 transmitter connector. These values should also be noted down in the SETTINGS table located at the end of this manual. On pressing 2 for Manual:

****XMTR CONFIG****
Enter xmtr A value:
0.03316

- Enter the PMC-2000 module A value then press Enter. The unit will prompt for the K and C values. Enter these followed by pressing the Enter key in each case.

3.3.2 DATA FILTER (SMOOTHING)

- Press the SETUP KEY if not already in the Setup menu), then press 3 for Settings, then 1 for Filter.

*****SETTINGS*****
Enter filter time

<u>HARDWARE REV.</u> 3.0	<u>SOFTWARE REV.</u> 2040_12 and higher	Page 11 of 26
-----------------------------	--	---------------

<u>MODEL</u> 2114OWS	<u>DOCUMENT TYPE</u> USER MANUAL	<u>DOCUMENT FILE NAME</u> 2114owsum43.doc	<u>REV.</u> 4.3
<u>CREATE DATE</u> January 17, 2006 10:11 AM	<u>REV. DATE</u> Feb.21/01	<u>PRINT DATE</u> March 6, 2006 10:10 AM	

in seconds:

0.0

- Enter the data response time in seconds for the unit to respond to a sudden change followed by the Enter key. For example a 5 second setting means the calculated value of the vessel capacitance and resulting values of level in % and engineering units will take 5 seconds to respond to an actual sudden change in vessel level.

3.3.3 ENGINEERING UNITS

- This parameter should be set before calibration, relay alarms, and mA output values are set. One of 8 units may be selected. These units do NOT cause any change in internal calculations, but are only used for clarity. For example, changing the engineering units from inches to centimeters does NOT change the displayed value, although it will affect the interpretation of values. For example, the calibration slope of oil is 4pF per inch. If the engineering units are changed from inches to centimeters, the slope should be changed to $4/2.54 = 1.57\text{pF per cm}$ for the calculations to be accurate. In addition to the slope value, relay alarms, and mA zero and span values should all be checked to make sure they are consistent with the intended engineering units.
- Press the SETUP KEY if not already in the Setup menu), then press 3 for Settings, then 2 for Units:

**** SELECT UNITS ****
1-in 2-ft 3-m 4-cm
5-lb 6-kg 7-L 8-gal
Current: gal

- Press the number for the desired units.

NOTE: THE FACTORY SLOPE VALUE (SEE CALIBRATION) IS ALWAYS GIVEN IN pF/INCH). IF OTHER ENGINEERING UNITS ARE CHOSEN (e.g. cm) THEN MAKE SURE THAT THE SLOPE IS RECALCULATED AND ENTERED FOR pF/cm.

CONTACT TECHNICAL SUPPORT FOR HELP IF NECESSARY.

3.3.4 TAG NUMBER

THE TAG NO.s ARE USED ONLY FOR NETWORK APPLICATIONS AND ARE USUALLY FACTORY SET. To communicate on a network, each controller must have a unique Tag Number (also called node address).

Important: if multiple units on a network have the same address, network errors will result.

An Arjay Central Access Panel (CAP) is required to communicate with 2000 series level controllers on a network. The CAP allows data to be viewed from and remote calibration / set of any 2000 series level controller on the network from a central location.

- Press the SETUP KEY if not already in the Setup menu, then press 3 for Settings, then 3 for Tag #.
- Enter the desired tag number.

3.3.5 mA SETTINGS

- Press the CONTROL key:

****CONTROL SETTINGS****

<u>HARDWARE REV.</u> 3.0	<u>SOFTWARE REV.</u> 2040_12 and higher	Page 12 of 26
-----------------------------	--	---------------

<u>MODEL</u> 2114OWS	<u>DOCUMENT TYPE</u> USER MANUAL	<u>DOCUMENT FILE NAME</u> 2114owsum43.doc	<u>REV.</u> 4.3
<u>CREATE DATE</u> January 17, 2006 10:11 AM	<u>REV. DATE</u> Feb.21/01	<u>PRINT DATE</u> March 6, 2006 10:10 AM	

1-Relay Settings
2-mA Settings

- Press 2 to setup the mA output:

***** SET mA OUT *****
Zero (in) 0.0
Span (in) 24.0

- The unit prompts for the Zero and Span in the chosen engineering units. Enter these values followed by the Enter key in each case. After the Enter key is pressed for the Span value, the following menu is displayed for additional mA settings:

***** SET mA OUT *****
Action: Direct
Type: 4-20mA
Press 1 to change

- The cursor will be on the Action setting line. Pressing 1 toggles between Direct and Inverse action. Direct action causes the 4mA to be output when the level is at the Zero setting and 20mA to be output when the level is at the Span setting. Inverse action is the reverse of Direct action. Press the ENTER key when done.
- The cursor now drops to the Type setting line. Pressing 1 toggles between 4-20mA and 0-20mA. The 0-20mA as the name implies, outputs a signal between 0-20mA instead of 4-20mA. The 0-20mA setting generally offers a little better measurement resolution.

3.3.6 RELAY SETTINGS

DESCRIPTION

RELAY1

This relay is dedicated for oil pump control i.e. controls the oil pump if excess oil is present in the separator.

Pump operation: When the oil level first exceeds the Oil Pump alarm point, RELAY 1 is activated for a programmable period of time. After the Run Time has elapsed, the pump turns off. The pump will remain off until water has replenished the separator, which will reset the relay. If oil continues to enter the separator at a higher rate than water, the oil volume will increase until further alarm relays are activated.

Note: the Pump Relay is normally de-energized when not in alarm. In the event of a power failure to the 2114 OWS, the pump will remain OFF.

RELAY2

Relay 2 is a system fault alarm. It is used to indicate a major error in the unit such as a faulty level probe or circuit card. The LED on the front panel lights up if an instrument failure occurs. The corresponding contacts for Relay 2, however, are normally energized, and de-energize in the event of an instrument failure.

RELAY3 & 4

Relays 3 and 4 are general purpose alarm relays. Setpoint considerations may be:

- a setpoint before the pumps turns on to indicate that oil is accumulating in the separator.

<u>HARDWARE REV.</u> 3.0	<u>SOFTWARE REV.</u> 2040_12 and higher	Page 13 of 26
-----------------------------	--	---------------

<u>MODEL</u> 2114OWS	<u>DOCUMENT TYPE</u> USER MANUAL	<u>DOCUMENT FILE NAME</u> 2114owsum43.doc	<u>REV.</u> 4.3
<u>CREATE DATE</u> January 17, 2006 10:11 AM	<u>REV. DATE</u> Feb.21/01	<u>PRINT DATE</u> March 6, 2006 10:10 AM	

- a setpoint higher than the pump setpoint to indicate that the pump is unable to evacuate the oil faster than new oil inflow.

- a setpoint near maximum oil capacity of the separator to close the inlet or outlet valve to the separator

For Failsafe and Action Settings for Relays 3 & 4 please refer to Section 4.3.2 – 4.3.4.

SETTING THE RELAYS

- Press the CONTROL key if not already in the Control Settings menu (see mA Settings display above). The press 1 for Relay Settings:

**** RELAY SETTINGS ****

1-Oil Pump (Relay1)

3-Relay3 4-Relay4

5-Disable Alrms (ENA)

- Disable the relays (factory default setting): The bottom line can disable Alarm relay alarms even if an Alarm condition exists. The factory default setting is OFF (DIS) which prevents Alarm relays from being activated until the unit is fully setup and calibrated. If ENA (i.e. relays are enabled) is displayed in the bottom corner then press 5 to disable relays. **Relays can be enabled AFTER calibration and setup are complete.**

- Press 1 to setup the Oil Pump relay (relay 1):

PUMP RELAY SETTINGS

ALRM VAL (in) 20.0

FIsafe=OFF/Action=HI

The bottom line of the LCD confirms that for the Pump Relay, the Failsafe is fixed to OFF, and the Action is High.

- Enter the Pump alarm point in the chosen engineering units followed by the Enter key. The pump alarm point (distance 'B' in fig. 2.1) should be chosen so that the end of the pump intake pipe is submerged in oil when the pump starts.
- The unit now prompts for the programmable On Delay. This is the time, in seconds, that oil should be allowed to exceed this alarm point before the pump is turned on.
- Next, the unit prompts for the programmable ON time for the pump (i.e. how long the pump is turned on for): enter the time in seconds followed by the Enter key. The time should be limited so that the oil does not fall below the suction intake tube of the pump, which would cause air to be drawn and the pump to run dry. The flowrate of the pump and volume vs. level of the separator will be needed to determine this accurately.

PUMP RELAY SETTINGS

ON delay (s): 0

ON time (s): 30

- Next setup general purpose alarm relays 3 and 4. If not already at the Relay Settings menu, press the CONTROL key, then 1 for Relay Settings, then 3 to setup relay 3:

<u>HARDWARE REV.</u> 3.0	<u>SOFTWARE REV.</u> 2040_12 and higher	Page 14 of 26
-----------------------------	--	---------------

<u>MODEL</u> 2114OWS	<u>DOCUMENT TYPE</u> USER MANUAL	<u>DOCUMENT FILE NAME</u> 2114owsum43.doc	<u>REV.</u> 4.3
<u>CREATE DATE</u> January 17, 2006 10:11 AM	<u>REV. DATE</u> Feb.21/01	<u>PRINT DATE</u> March 6, 2006 10:10 AM	

*** RELAY 3 SETTINGS ***

Action: HI (1 for LO)
Fisafe: OFF(1 for ON)

- Select the Alarm Action by pressing 1 to toggle between High and Low action. See Section 4.3.2 – 4.3.4 for help in selecting this value. Press ENTER after selecting Action.
- Next select the Failsafe type by pressing 1 to toggle between On and Off. See Section 4.3.2 – 4.3.4 for help in selecting this value. Press ENTER after selecting the Failsafe type.
- After selecting the Failsafe setting the following menu is displayed.:

*** RELAY 3 SETTINGS ***
ALRM VAL (in) 5.00
On Delay (sec): 0

- Enter the oil pump alarm point in the chosen engineering units followed by the Enter key.
- Setup Relay 4 in a similar way.

3.3.7 CALIBRATION

Calibration involves:

1. Entering the Slope or capacitance change per change in the level of oil. This is entered at the factory and is usually around 4pF per inch of oil for a 2 inch concentrically shielded probe (Standard probe for oil measurements).
2. Auto cal: One point calibration which enters the actual amount of oil in the chosen engineering units. This is usually done at 0% oil.

3.3.7.1 CHECK OIL SENSITIVITY (SLOPE) SETTING

- DO THIS FIRST BEFORE AUTOCAL SINCE CHANGING THIS VALUE WILL REQUIRE REDOING AUTOCAL.
- Press the CALIB key then 4 for Slope / Offset.
- Verify that the slope value is correct. Check the slope value listed in the SETTINGS SHEET in section 6.0 or with Arjay Technical Support. To modify, enter in the new value followed by the Enter key. If no change, just press the Enter key. NOTE: the Slope prompt is in pF / xxx where xxx are the engineering units chosen in section 3.3.3. Arjay slopes are specified in pF / inch only. To use other engineering units such as cm, the slope in pF/inch must first be changed to pF/cm.
- The Offset value should not be modified. It is automatically set after a successful calibration (either the Quick or Full 2 point procedure). It is the capacitance value corresponding to water only (no oil). Increasing levels of oil will decrease the measured capacitance starting from this value and changing at the rate set by the slope value i.e. typically 4pF per inch of oil.

3.3.7.2 QUICK CAL (ONE POINT)

- If not at the CALIBRATION menu, press the CALIB menu key then 1 for Quick Calibration.

<u>HARDWARE REV.</u> 3.0	<u>SOFTWARE REV.</u> 2040_12 and higher	Page 15 of 26
-----------------------------	--	---------------

<u>MODEL</u> 2114OWS	<u>DOCUMENT TYPE</u> USER MANUAL	<u>DOCUMENT FILE NAME</u> 2114owsum43.doc	<u>REV.</u> 4.3
<u>CREATE DATE</u> January 17, 2006 10:11 AM	<u>REV. DATE</u> Feb.21/01	<u>PRINT DATE</u> March 6, 2006 10:10 AM	

- Measure the actual level of oil in the same engineering units chosen in section 3.3.3. For new installations, there is usually no oil present in which case the Autocal value should be 0.

3.3.7.3 ACTIVE PROBE LENGTH

NOTE: THIS VALUE IS ONLY USED TO CALCULATE AND DISPLAY OIL IN % MAXIMUM CAPACITY. It is NOT USED in calibration, or to set alarms, or the mA output, all of which must be entered in the chosen engineering units. It is specified as the length on the probe used to measure the full range of oil anticipated by the application. Note: The Active Probe Length typically does not include the entire length of the probe, but just the length over which the 0-100% oil is to be measured.

NOTE: The Active Probe Length is entered in the chosen engineering units. i.e. if the engineering units are in kg (assuming the kg of oil in the vessel is proportional to vertical depth and the SLOPE was entered in pF/kg) then the value entered should be the maximum kg of oil capacity of the vessel.

- Press the CALIBRATION key to get to the CALIBRATION menu, then 5 for Active Probe Length.
- The unit prompts for the maximum capacity of the vessel IN THE ENGINEERING UNITS CHOSEN IN SECTION 3.3.3. Enter the vessel maximum value then press the Enter key.

3.3.8 ENABLE ALARM RELAY CONTROL

- If the Alarm Relays are being used, now that calibration has been successfully completed, the Alarm Relay control may be re-enabled.
- Press the CONTROL key to get to the CONTROL menu, then 1 for Relay Settings then 5 to Enable.
- The right, bottom corner of the display should show ENA for Enabled.
- Press the DISPLAY key to go back to the Display menu.

THIS COMPLETES THE SETUP AND CALIBRATION PROCEDURE
NO FURTHER SETUP OR CONFIGURATION IS REQUIRED
THE NEXT SECTION (4) IS FOR REFERENCE ONLY

<u>MODEL</u> 2114OWS	<u>DOCUMENT TYPE</u> USER MANUAL	<u>DOCUMENT FILE NAME</u> 2114owsum43.doc	<u>REV.</u> 4.3
<u>CREATE DATE</u> January 17, 2006 10:11 AM	<u>REV. DATE</u> Feb.21/01	<u>PRINT DATE</u> March 6, 2006 10:10 AM	

4.0 OPERATION

IN THE FOLLOWING TEXT A MENU WILL BE DISPLAYED AS A PATH. FOR EXAMPLE THE AUTOCAL MENU: [CALIB\ 1]. (CALIB key then 1 for QUICK).
 SETTINGS MENU: [SETUP\3] (SETUP key then 3 for SETTINGS).

The 2000 Oil Level Monitor uses a high precision and highly repeatable RF technique to measure capacitance which in turn is used to calculate level. The capacitor formed by the Teflon sheathed level probe (mounted vertically into the vessel) and probe shield decreases in capacitance linearly as the level of oil increases.

THE INSTRUMENT ASSUMES THAT THE OVERALL LEVEL IN THE VESSEL IS ALWAYS THE SAME AND THE ONLY CHANGE IS THE LEVEL OF THE OIL/WATER INTERFACE. i.e. only one variable. The Arjay Capacitance probe type used is a concentrically shielded probe. This arrangement makes the probe installation independent of most other parameters other than the dielectric change between the Teflon sheathed probe and the surrounding concentric shield. This allows factory calibration of the SLOPE i.e. the change of capacitance per selected engineering unit (typically inches) of oil along the probe. The only field calibration required is a Single Point Calibration to set the 0 level oil capacitance. This may be done at any oil level and not necessarily at 0% oil, although this is often the most convenient. During the Single Point Calibration, the instrument uses the SLOPE value and the current actual oil level value entered by the user to calculate the capacitance at 0% oil.

Four alarm contacts are provided: A pump contact is provided to turn on a pump when the oil level rises above a user selectable oil pump setpoint. In the event of an oil spill, when the oil level rises above this setpoint, the pump contacts are activated. IN AN ALARM CONDITION IT IS ASSUMED THAT THE PUMPED OUT OIL MAY BE REPLACED WITH AIR INSTEAD OF WATER (ABNORMAL CONDITION). This would have the effect of further decreasing the measured capacitance thus fooling the instrument into believing that the oil level is increasing and so preventing the pump from turning off. To prevent this runaway problem, the pump contacts are activated for a user selectable amount of time. The time chosen should be long enough for the particular pump size to pump out the maximum expected oil in the vessel. The pump contacts are then de-activated. The alarm condition is however not reset until the measured oil level falls below the pump setpoint. This makes sure that some oil was pumped out even though it may have been replaced with air. In the event that the pump cannot keep up with the oil inflow, 2 other relays are provided. One of them may be set to alarm at an oil level higher than the oil pump setpoint. This alarm relay would alarm to indicate the pump cannot keep up. The third relay setpoint may be set to an oil level higher than the previous relay setpoint and is typically used to shut off the main valve into the Oil/Water Separator as a final resort. An additional relay is provided to indicate instrument failure.

All Level-Ease 2000 Series Controllers and Transmitters are intelligent and can perform a number of tasks simultaneously (multitasking software). This means that even while in another menu, the capacitance is always measured in the background. For example if the Filter value is being set in the SETTINGS submenu (SETUP\SETTINGS menu), the level value, relay alarms and mA outputs are still being updated. This is important since keypad entries are typically slow and sometimes an operator might forget to return the unit to the normal DISPLAY menu: in this case Alarm relays and mA output are still updated. In some menus however, the mA output and or the Alarm Relays are not updated on purpose; for example while in the calibration menu, the unit assumes that the unit is being calibrated and so the calculated level may be erroneous. In this case, the mA and Alarm Relays are set to the inactive states.

<u>HARDWARE REV.</u> 3.0	<u>SOFTWARE REV.</u> 2040_12 and higher	Page 17 of 26
-----------------------------	--	---------------

<u>MODEL</u> 2114OWS	<u>DOCUMENT TYPE</u> USER MANUAL	<u>DOCUMENT FILE NAME</u> 2114owsum43.doc	<u>REV.</u> 4.3
<u>CREATE DATE</u> January 17, 2006 10:11 AM	<u>REV. DATE</u> Feb.21/01	<u>PRINT DATE</u> March 6, 2006 10:10 AM	

Periodically, (every 5-10 seconds) the unit does a self diagnostic. If major errors are found they are displayed on the LCD. These error messages take precedence over the level information in the DISPLAY menu ONLY. All other menus may be entered and parameters viewed or changed. In case of errors, this allows the user to enter the DIAGNOSTICS menu and check the capacitance or frequency etc.

4.1 DISPLAY MENU [DISP]

This is the default or normal operating screen. It shows:

OIL LEVEL
3.28 in
27.33 %
▄▄▄

NOTE: The shown values are for example only.

The 2nd line shows the oil level in engineering units. One of 8 engineering units may be selected.

The 3rd line shows the oil level in percent. This value is independent of the engineering units.

The 4th line displays a bargraph of the percent capacity. The resolution is 5%.

The Status Indicator (see figure 3.0) should be green. If this is red then the LCD displays the kind of System Error. See the troubleshooting guide for details.

4.2 CALIBRATION [CALIB]

This is described in section 3.3.7 and in OPERATION above.

4.3 CONTROL MENU [CONT]

The CONTROL menu allows the setup of the mA output and the Control Relays.

NOTE: The Control Relays and the mA output are set to their OFF states when in the CALIBRATION menu [CALIB]. In the DIAGNOSTICS menu [FUNCTION \ 2], the 20mA output may be set manually by the operator to 4mA, 20mA or any user selectable value between 0 and 20mA. In this case the mA output does not reflect the level value.

4.3.1 mA SETTINGS

The mA output Zero and Span settings may be set anywhere within the measurement range. For example, if the Zero is set to 5 inches of oil and the Span is set at 10 inches of oil then the mA output is scaled between these two points with the mA output indicating low level at 5 inches and high level at 10 inches of oil. These values are for example only. Typically, the zero value is set to 0 inches of oil.

The mA output may also be set to Direct or Inverse Acting. In Direct Action, the mA output is 4mA when the level is at the Zero level and 20mA when at the Span level. In Inverse Action, the mA output is 20mA when the level is at the Zero level and 4mA when at the Span level.

4.3.2 RELAY SETTINGS

Relays 1 and 2 are fixed for Oil Pump control and Instrument Failure respectively. Relays 3 and 4 are general purpose and may be used for alarms or control such as pumps, valves and other equipment based on Oil level values.

Below are user selectable options for Relays 3 and 4.

Four parameters are available for Relays 3 and 4:

<u>HARDWARE REV.</u> 3.0	<u>SOFTWARE REV.</u> 2040_12 and higher	Page 18 of 26
-----------------------------	--	---------------

<u>MODEL</u> 2114OWS	<u>DOCUMENT TYPE</u> USER MANUAL	<u>DOCUMENT FILE NAME</u> 2114owsum43.doc	<u>REV.</u> 4.3
<u>CREATE DATE</u> January 17, 2006 10:11 AM	<u>REV. DATE</u> Feb.21/01	<u>PRINT DATE</u> March 6, 2006 10:10 AM	

1. HIGH ALARM (or SET) POINT. This value is specified in the chosen engineering units. Above this value, relay action is taken depending on the Relay Action and Failsafe settings.
2. RELAY ACTION. High or Low Action. Selecting high action will set the relay to an alarm state when the level exceeds the alarm point for at least the time delay period. An LED on the front panel for the appropriate relay indicates the alarm condition. The relay is set to a non alarm state (with no delay) when the level falls below the alarm point. Selecting low action will set the relay to an alarm state when the level falls below the control point for at least the time delay period. The relay is set to a non alarm state (with no delay) when the level rises again above the control point. The relay alarm state i.e. normally energized or not energized is set by the Failsafe setting described next.
3. FAILSAFE. Failsafe ON typically means that the relay is normally energized when not in alarm. In an alarm condition, the relay is de-energized i.e. identical to when the instrument power is shut off. Setting the Failsafe OFF, keeps the relay normally de-energized when not in alarm. Note: regardless of the alarm condition, the corresponding relay LED on the front panel is always ON when in an alarm state.
4. RELAY DELAY. Minimum time in seconds for an alarm to exist before the corresponding relay is set to its alarm state. The relay alarm state depends on the Relay Action and Failsafe settings.

4.3.3 RELAY SETTINGS SELECTION

1. Identify the positive action required in the control application such as turning on a pump, opening a valve, or sounding an alarm. Note: the time delay is applied to the start of the positive action; also, the corresponding LED is turned on to indicate the positive action.
2. Identify if Fail Safe condition is required in an alarm condition. If the Positive Action is the same as in a Power Fail condition then Fail Safe setting should be ON. Typically control applications (relay used to control pump etc.), the positive action has the opposite state as that required in the event of a power or instrument failure so Fail Safe is typically OFF. For alarm applications (relay used to indicate an abnormal condition such as a high tank level), the positive action typically is the same state desired as in the event of a power or instrument failure so the Fail Safe condition is typically ON.
3. Identify the type of relay action required: if the positive action is required when the level exceeds the control point then select High Action for the relay. If the positive action is required when the level falls below the control point then select Low Action.
4. Identify the relay contacts to use (either Normally Open or Normally Closed). The contacts used are dictated by the failsafe setting and if the positive action requires the application of power or removal of power to the controlled device.

The following table summarizes the settings for all possible requirements:

#	DESIRED CONTACT CONDITIONS			DO THIS		
	BELOW LOW SETPOINT	ABOVE HIGH SETPOINT	INSTRUM. Or PWR FAILURE	FAILSAFE SETTING	RELAY ACTION	USE CONTACTS
1	Open	Closed (PA)	Open	No	High Acting	NO
2	Open	Closed (PA)	Closed	Yes	High Acting	NC
3	Closed (PA)	Open	Open	No	Low Acting	NO

<u>MODEL</u> 2114OWS	<u>DOCUMENT TYPE</u> USER MANUAL	<u>DOCUMENT FILE NAME</u> 2114owsum43.doc	<u>REV.</u> 4.3
<u>CREATE DATE</u> January 17, 2006 10:11 AM	<u>REV. DATE</u> Feb.21/01	<u>PRINT DATE</u> March 6, 2006 10:10 AM	

4	Closed (PA)	Open	Closed	Yes	Low Acting	NC
5	Open (PA)	Closed	Closed	No	Low Acting	NO
6	Open (PA)	Closed	Open	Yes	Low Acting	NC
7	Closed	Open (PA)	Closed	No	High Acting	NO
8	Closed	Open (PA)	Open	Yes	High Acting	NC

- (PA) = positive action desired such as turning on a pump.
- Conditions 1, 3, 5, 7 are typically for control applications where the positive action i.e. turning on a pump, should be shut off during a power failure to the Arjay level controller.
- Conditions 2, 4, 6, 8 are typically for alarm applications where the positive action i.e. sounding an alarm if the level is at a high level, should also be in place during a power failure to the Arjay level controller.

4.3.4 RELAY SETTINGS EXAMPLE

An alarm buzzer and light must be turned on if the level in a tank exceeds 5 inches of oil or in the event of an instrument or power failure.

Settings:

Control point: 5 inches (Alarm setpoint for Relay 3 or 4)

Failsafe: Yes

Relay action: High acting

Contacts used: Normally Closed

Explanation:

In this case the positive action is turning on a buzzer and light.

Since the buzzer / light should also be turned on if the Arjay unit fails or in the event of a power failure i.e. the positive action state is the same as the failure state, the failsafe setting should be Yes.

Since the positive action is desired when the level rises above the control point, the relay setting should be High Acting.

Since the buzzer / light require power to turn on, and the failsafe setting is Yes, the normally closed contacts should be used.

In an alarm application, the alarm time delay should be set as low as possible.

4.4 SETUP [SETUP]

The FUNCTION menu is used for one-time setup and for Diagnostics.:

*****SETUP*****
1-PMC 2000 2-Diags
3-Settings

4.4.1 PMC 2000 (Manual) [SETUP \ 1 \ 2]

This menu is to calibrate the 2000 series controller for the particular PMC-2000 level transmitter module located at the probe head. There are 3 calibration parameters: A, K, C. These values are used to calculate the capacitance from the frequency signal received from the PMC-2000. The parameters may be calibrated manually or automatically. Automatic Calibration is performed at the

<u>HARDWARE REV.</u> 3.0	<u>SOFTWARE REV.</u> 2040_12 and higher	Page 20 of 26
-----------------------------	--	---------------

<u>MODEL</u> 2114OWS	<u>DOCUMENT TYPE</u> USER MANUAL	<u>DOCUMENT FILE NAME</u> 2114owsum43.doc	<u>REV.</u> 4.3
<u>CREATE DATE</u> January 17, 2006 10:11 AM	<u>REV. DATE</u> Feb.21/01	<u>PRINT DATE</u> March 6, 2006 10:10 AM	

factory on each PMC-2000 module. The A,K,C values are then affixed by a label on the connector. AUTOMATIC CALIBRATION IS ONLY TO BE PERFORMED BY AUTHORIZED PERSONNEL AND IS BEYOND THE SCOPE OF THIS MANUAL. IF PROBLEMS ARE ENCOUNTERED OR IF THE A,K,C VALUES ARE NOT KNOWN PLEASE CONTACT AN ARJAY REPRESENTATIVE.

Manual entry of the A,K,C values is described in Section 3.3.1

4.4.2 DIAGNOSTICS [SETUP \ 2]

This menu displays the received frequency signal from the PMC-2000 module at the probe head and the calculated capacitance. Both of these values are useful in determining calibration or performance problems.

****DIAGNOSTICS****
12.04pF 4461.48Hz

1-4mA 2-20mA 3-Other

Pressing key 1 forces the mA output to 4mA. Similarly pressing key 2 forces the mA output to 20mA. Any other value between 0 and 20 may be set by pressing 3 for "Other" then entering the desired mA output value.

This feature is convenient to check the performance of external recorders or PLC's, which read the mA output. The mA output reverts back to its actual level when the normal Display Menu is selected.

4.4.3 SETTINGS MENU [SETUP \ 3]

This menu sets the digital filter and the engineering units. In addition the mA output may be trimmed for maximum accuracy. Also the Tag number and Software revision may be viewed:

***** SETTINGS *****
1-Filter 2-Units
3-Tag # 4-mA Trim
2114 Rev:2040_12

mA TRIM:

This procedure trims the mA output for maximum accuracy by compensating for the mA output circuitry tolerances. THIS PROCEDURE IS PERFORMED ON EVERY TRANSMITTER AT THE FACTORY AND IS TO BE PERFORMED BY AUTHORIZED PERSONNEL ONLY. IF IMPROPERLY DONE, THE ACCURACY OF THE mA OUTPUT IS AFFECTED.

Under certain conditions this procedure may be undertaken in the field with Arjay's permission:

- Press the SETUP key, then 3 for Settings and then 4 for mA Trim. The unit should put out what it thinks is 20.0mA.
- Disconnect any load connected to the mA output of the transmitter.
- With an ACCURATE MULTIMETER MEASURE THE mA OUTPUT. The Multimeter should have at least one place of decimal.
- Enter this value at the prompt and press the Enter key. A maximum tolerance adjustment of 3% is allowed i.e. the entered value must be in the range of 19.4mA to 20.6mA. If a value

<u>HARDWARE REV.</u> 3.0	<u>SOFTWARE REV.</u> 2040_12 and higher	Page 21 of 26
-----------------------------	--	---------------

<u>MODEL</u> 2114OWS	<u>DOCUMENT TYPE</u> USER MANUAL	<u>DOCUMENT FILE NAME</u> 2114owsum43.doc	<u>REV.</u> 4.3
<u>CREATE DATE</u> January 17, 2006 10:11 AM	<u>REV. DATE</u> Feb.21/01	<u>PRINT DATE</u> March 6, 2006 10:10 AM	

out of this range is entered an error is flashed on the screen. If this occurs, contact an Arjay representative for assistance.

FILTER, ENGINEERING UNITS, TAG #:

These settings are described in Section 3.3.2, 3.3.3, and 3.3.4 respectively.

<u>MODEL</u> 2114OWS	<u>DOCUMENT TYPE</u> USER MANUAL	<u>DOCUMENT FILE NAME</u> 2114owsum43.doc	<u>REV.</u> 4.3
<u>CREATE DATE</u> January 17, 2006 10:11 AM	<u>REV. DATE</u> Feb.21/01	<u>PRINT DATE</u> March 6, 2006 10:10 AM	

5.0 TROUBLESHOOTING

CONDITION	DO THIS
1. DISPLAY MENU SHOWS: Error: No Xmtr Signal (In addition, Relay 2 is de-energized to indicate a Status Alarm)	The unit is not receiving a frequency signal from the remote PMC-2000 level transmitter in the probe head: Check wiring. If wiring checks out: call Arjay Technical Support. An adjustment may be made at the controller.
2. DISPLAY MENU SHOWS: Error: Setup Values Bad. (In addition, Relay 2 is de-energized to indicate a Status Alarm)	This indicates that one of the calibration or setup parameters has been corrupted. Compare ALL parameters with the table in Section 6.0 to indicate which one. Re-enter it Call Arjay Technical Support
3. DISPLAY MENU SHOWS: Error: pF out of range. (In addition, Relay 2 is de-energized to indicate a Status Alarm)	The calculated capacitance is out of the legal range: Check if the A,K,C values in the unit correspond to the A,K,C values of the PMC-2000 transmitter. Check the integrity of the Teflon sheath of the probe. If this has been damaged, water could cause an electrical short circuit between the probe within the Teflon sheath and the ground reference. In this case a very high capacitance is usually registered. Check the Xmtr frequency in the Diagnostics menu. If the frequency is around 2300 Hz or below then a short should be suspected. To confirm: Open the probe head and disconnect the blue wire from the probe to the PMC-2000. Using a DVM, measure the resistance between the enclosure case and the probe tip. It should read infinite resistance or OL. Make sure that fingers and hands do not touch the metal portion of the probes of the DVM since this could show a lower resistance: 1-10mohms. Contact an Arjay Representative.
4. DISPLAY MENU SHOWS: Error: Memory Failure. (In addition, Relay 2 is de-energized to indicate a Status Alarm)	The storage memory has been found to be bad. Call Technical Support for help.
5. The level reading is erratic or unstable	Check the Slope value. If this is lower than about 0.5pF per percent then check if the level displayed agrees with the actual level in the vessel at a number of different levels. If so, then check if the probe is being splashed by incoming liquid or if there are moving mixer parts (especially metallic) close to the probe. If this is true, then try increasing the Filter time setting. If this is not enough, and the cause of the disturbance cannot be rectified then a concentrically shielded probe must be used.
6. Readings are not accurate i.e. the displayed values are not accurate as the level moves	For probes without a factory supplied concentric shield, make sure the probe is parallel to its

<u>HARDWARE REV.</u> 3.0	<u>SOFTWARE REV.</u> 2040_12 and higher	Page 23 of 26
-----------------------------	--	---------------

<u>MODEL</u> 2114OWS	<u>DOCUMENT TYPE</u> USER MANUAL	<u>DOCUMENT FILE NAME</u> 2114owsum43.doc	<u>REV.</u> 4.3
<u>CREATE DATE</u> January 17, 2006 10:11 AM	<u>REV. DATE</u> Feb.21/01	<u>PRINT DATE</u> March 6, 2006 10:10 AM	

<p>away from the calibration points.</p>	<p>ground reference which may be the tank wall or the inside of a stilling pipe (if probe is installed in a pipe). See Probe Installation SECTION 2.2 for more details.</p> <p>For probes with a factory supplied concentric shield, make sure the pressure equalizing slots / holes in the shield are unobstructed i.e. the liquid level inside and outside the shield are always the same.</p>
--	--

<u>MODEL</u> 2114OWS	<u>DOCUMENT TYPE</u> USER MANUAL	<u>DOCUMENT FILE NAME</u> 2114owsum43.doc	<u>REV.</u> 4.3
<u>CREATE DATE</u> January 17, 2006 10:11 AM	<u>REV. DATE</u> Feb.21/01	<u>PRINT DATE</u> March 6, 2006 10:10 AM	

6.0 CONTROLLER SETTINGS SHEET

Checked by	
Model Number	
Serial Number	
Software Rev.	

PARAMETER	DESCRIPTION	FACTORY SETTING	USER SETTING
Probe A value	Probe PMC-2000 level transmitter calibration value		
Probe K value	Probe PMC-2000 level transmitter calibration value		
Probe C value	Probe PMC-2000 level transmitter calibration value		
Slope	Factory installed value of capacitance per level change of oil	4 pF / inch	
Offset	Result of a successful Calibration: Calculated capacitance for 0% oil.		
Active Probe Length	Active part of probe measured from the probe bottom.	24 inches	
Zero	Zero Level value for mA output (in chosen engineering units).	0 inches	
Span	Full Scale Level value for mA output (in chosen engineering units).	24 inches	
mA Action	Direct (20mA when level at Span) or Inverse (4mA when level is at Span)	DIR	
Pump Hi Set (Relay 1)	Pump (Relay 1) high alarm: pump (relay 1) turned on for a selectable time when oil level exceeds this value. The pump will not turn on again until the level drops below this value. Note: alarm value in chosen engineering units)	5 inches	
Pump On Delay	Amount of time the oil level must be above the Pump High Setpoint before the pump relay is energized	0 sec	
Pump On time (Relay 1)	The time in seconds for which the pump is turned on when the oil level first exceeds the PUMP HI SET value (Relay 1 Hi Set).	2 sec	
Pump Failsafe (Relay 1)	This relay is forced to normally de-energized (Failsafe = OFF) since it controls a pump which should be OFF if power to the 2114 OWS is removed.	OFF	No change allowed
Relay2 Hi Set	This relay is reserved to indicate Instrument Failure. It has no user settable settings.	N/A	No change allowed
Relay2 Failsafe	This relay is forced to normally energized (no alarm) and de-energized in an alarm condition or power failure.	ON	No change allowed

<u>HARDWARE REV.</u> 3.0	<u>SOFTWARE REV.</u> 2040_12 and higher	Page 25 of 26
-----------------------------	--	---------------

<u>MODEL</u> 2114OWS	<u>DOCUMENT TYPE</u> USER MANUAL	<u>DOCUMENT FILE NAME</u> 2114owsum43.doc	<u>REV.</u> 4.3
<u>CREATE DATE</u> January 17, 2006 10:11 AM	<u>REV. DATE</u> Feb.21/01	<u>PRINT DATE</u> March 6, 2006 10:10 AM	

Relay3 Hi Set	Alarm Relay 3 high alarm: alarm condition if level is above this value (value in chosen engineering units).	10 inches	
Relay3 Failsafe	Failsafe of ON sets the relay as normally energized (no alarm) and de-energized in an alarm condition.	ON	
Relay 3 Alarm Delay	Amount of time the level must be in an alarm condition (based on Relay 3 alarm value and Action settings) before the relay is set to the alarm condition (condition set by Relay 3 Failsafe setting).	0 sec	
Relay4 Hi Set	Alarm Relay 4 high alarm: alarm condition if level is above this value (value in chosen engineering units).	15 inches	
Relay4 Failsafe	Failsafe of ON sets the relay as normally energized (no alarm) and de-energized in an alarm condition.	ON	
Relay 4 Alarm Delay	Amount of time the level must be in an alarm condition (based on Relay 4 alarm value and Action settings) before the relay is set to the alarm condition (condition set by Relay 4 Failsafe setting).	0 sec	
Alarm Enable	Master Alarm Relay Enable: If Off this will prevent relays from being reflecting the Alarm condition. The relay will remain in the non alarm condition base on the Fail-safe switch setting on the relay modules	ON	
Filter	Digital Filter response time in seconds. Used to smooth out level fluctuations caused by splashing etc.	0 sec	
Engineering Units	Eng. units chosen to display level information in addition to the level in %.	in (inches)	
Tag Number	For network applications only. All Arjay 2000 series controllers connected to a network must have a unique Tag Number between 1 and 100	1	

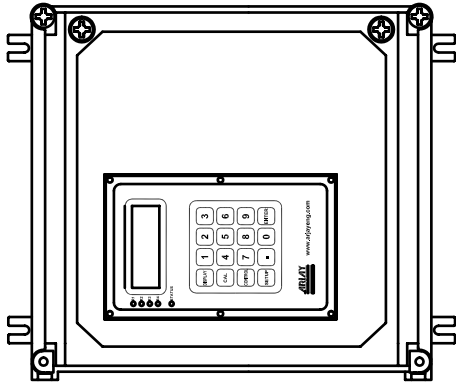

ENCLOSURE:
NEMA 4X, FIBERGLASS
14.5" X 12" X 7.5" DEEP

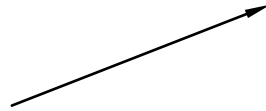

ROUND

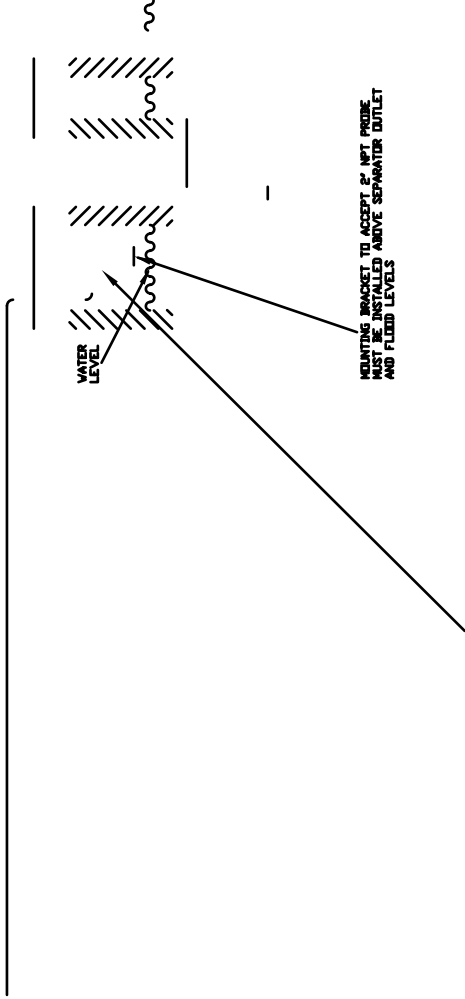

1 11/27/00 UPDATED DVS TANK, MOUNTED CONTROLLER IN ENCLOSURE

